

A person wearing a white helmet and a dark jacket is riding a black motorcycle on a paved road. The road has orange double lines and curves to the right. The background shows lush green trees and a beach with waves under a blue sky. The overall scene is bright and sunny.

DAYTONA

2024-2025

**HIGH PERFORMANCE PARTS AND ACCESSORIES
FOR ALL THE MOTORCYCLE LOVERS
SINCE 1972**

DAYTONA

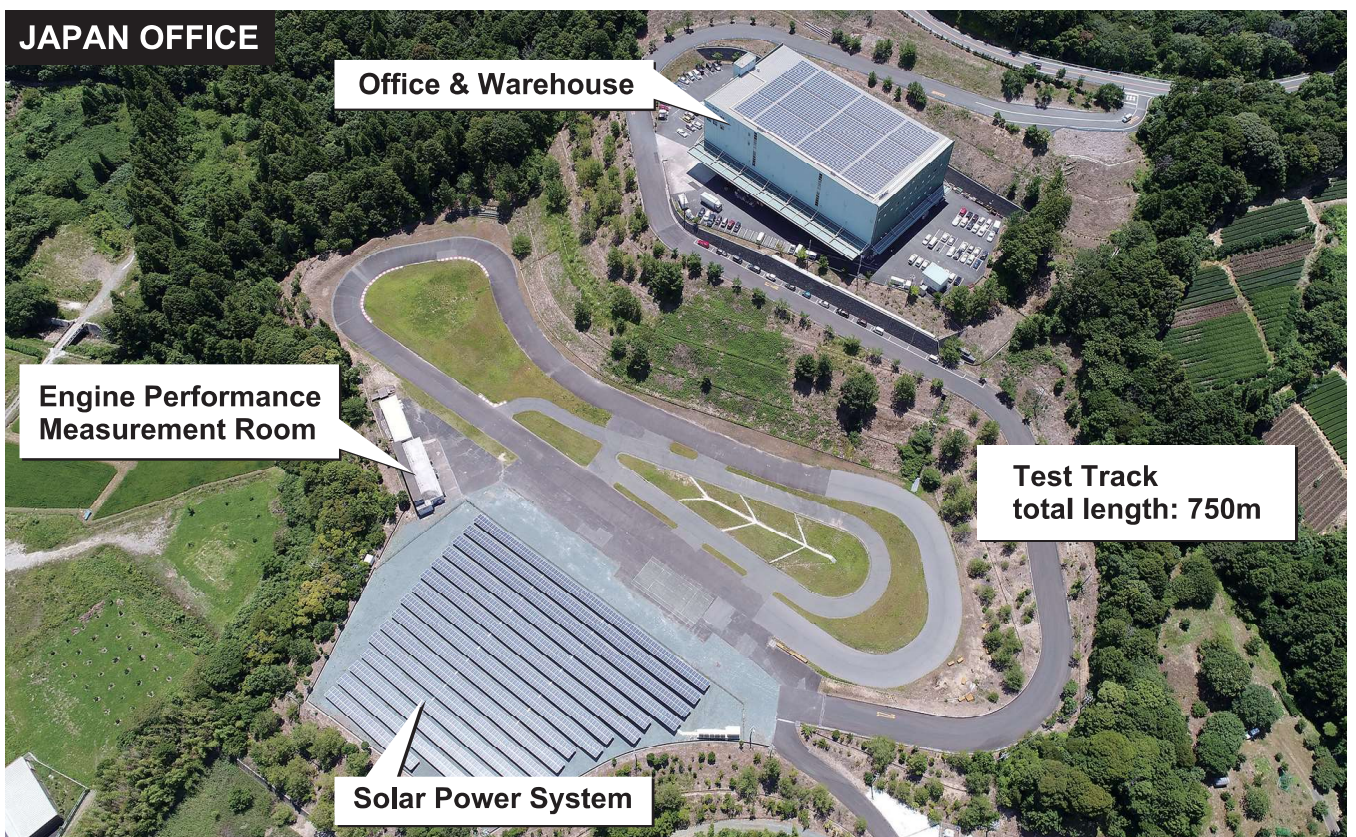

DAYTONA CORPORATION

4805 Ichimiya, Mori-machi,
Shuchi-gun, Shizuoka, 437-0226, Japan
<https://daytona-europe.com>

Message

Welcome to Daytona Japan!

For over 50 years, we've been passionate about creating high-quality motorcycle parts that riders love. As a top brand in Japan, we take pride in our legacy and commitment to the motorcycle community.

At Daytona Japan, we believe in enhancing every ride. Our extensive range of innovative customization parts and cutting-edge accessories is designed to elevate the riding experience for enthusiasts around the world.

Whether you're seeking performance, style, or reliability, our products are crafted to meet the diverse needs of every motorcycle and rider.

With a strong global presence, we're proud to serve customers from all corners of the world. Our mission is simple: to ensure that every rider can enjoy the thrill of the open road with confidence and excitement, powered by our reliable and exhilarating motorcycle parts.



**Join us on this exciting journey
and experience the Daytona Japan
difference.**

Happy riding!

**President
Tetsu, Oda**



Handlebar Control Switch

NEW

■ 3-Button Control switch



#81254 Chrome button

#81371 Black chrome button

- Housing: CNC aluminum
- Button: Coated ABS
- For 22.2/25.4mm handlebars
- Max. current 50mA
- No need to drill hole on handlebar
- Need relay to function
- Incl. icon stickers

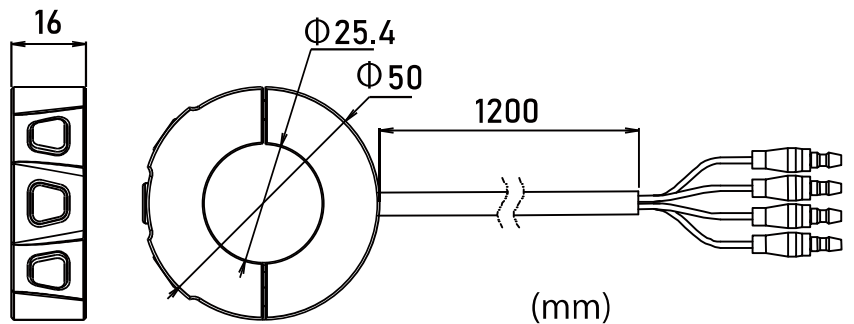



Key Features

- Compatible with both 6V & 12V systems (Operating voltage: 6–18V DC)
- Built-in turn signal relay for easy wiring
- Compact design: 75x30x20mm, made from durable ABS material
- Auto-cancel function for turn signals
- Supports up to 8 switch connections for a fully customizable setup
- Works with Daytona handlebar switches and common momentary-type switches
- Reverse current protection to prevent damage
- Waterproof (IP67) for reliable performance in all weather conditions
- CE approved

Input:

- ACC IN (Max 20A), GND IN

Outputs:

- Left and right turn signals (L OUT, R OUT), max. 5A each
- Headlight (HI OUT, LOW OUT), max.10A each
- Horn (HORN OUT), max. 10A
- Starter relay (START OUT), max. 15A
- Accessories (ACC OUT), max. 10A
- Optional output 1 (OPT1 OUT – e.g., fog lights), max. 10A
- Optional output 2 (OPT2 OUT – for pass switch), max. 10A
- Optional output 3 (OPT3 OUT – for kill switch), max. 15A



#81255











VELONA60-WP



NEW



#81443

-  SPEED & RPM
-  200km/h (MPH)
-  0-20,000rpm
-  0-99,999.9km (mile)
-  1 & 2, 0-9,999km (mile)
-  DC 10.0-16.0V
-     Indicators

- Aluminum housing
- Incl. V-shaped bracket

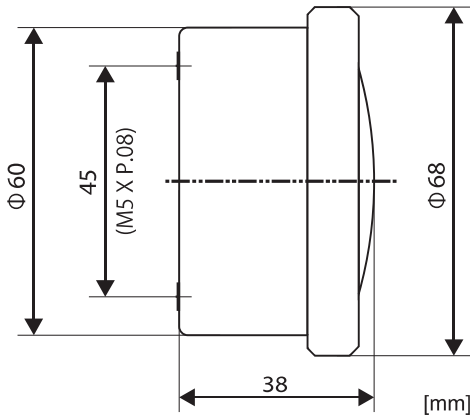

New white panel!



VELONA-W

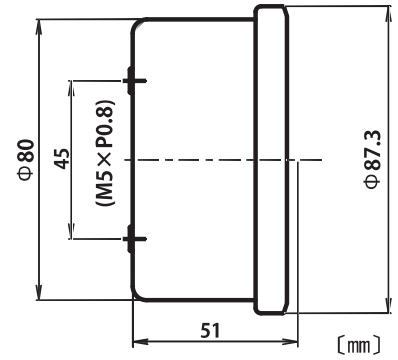

#89364



Two Needles (SPEED & RPM)



200km/h (MPH)



0-9,000rpm



0-99,999.9km (mile)



1 & 2, 0-99,999.9km (mile)



DC 10.0-16.0V



Memory & Recall



Indicators

- Stainless-steel housing
- Incl. V-shaped bracket



Photo by : JSL MOTO

VELONA80



Photo by : Schepers Motoren Design



#87789
[140]



#87790
[200]



#87791
[260]



#87792
[9000]



#87793
[15000]

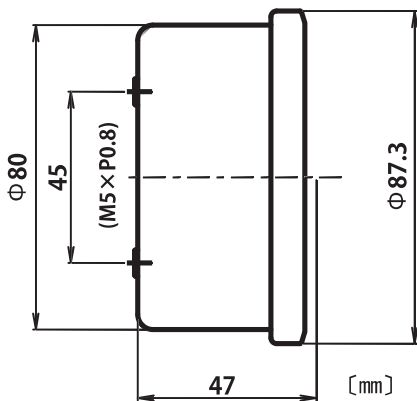

- Stainless-steel housing
- Incl. V-shaped bracket

- 140/200/260 km/h (MPH)
- 0-20,000rpm
- 0-99,999.9km (mile)
- 1 & 2, 0-99,999.9km (mile)
- DC 10.0-18.0V
- Memory & Recall
- with Red LED lamp
- Indicators

- 0-399km/h (0-260MPH)
- 9000rpm / 15000rpm
- 0-99,999km/h(mile)
- 1 & 2, 0-99,999.9km (mile)
- DC 10.0-18.0V
- Memory & Recall
- with Red LED lamp
- Indicators

VELONA60



Photo by : JM Customs

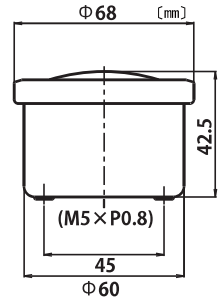

■ SPEED (km/h or MPH)



#88641
[140]



#88642
[200]



#88643
[260]



#86267
[260]

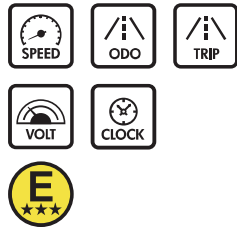

■ RPM



#88644
[9000]



#88645
[15000]



#88677
[15000]





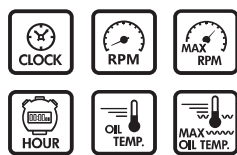



#87527
[15000]



Digital VELONA



#85836

-  SPEED & RPM
-  0-399km/h (0-250MPH)
-  0-20,000rpm
-  0-99,999km(mile)
-  1 & 2, 0-9,999.9km(mile)
-  RPM bar-scale programmable

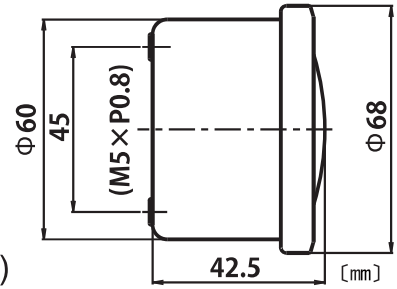



- Stainless-steel housing
- Incl. V-shaped bracket

VELONA-Volt



#80859

#80860

-  8.0-16.0V
-  Low voltage alert by Red LED backlight when less than 12V

- Stainless - steel housing
- Incl. V-shaped bracket

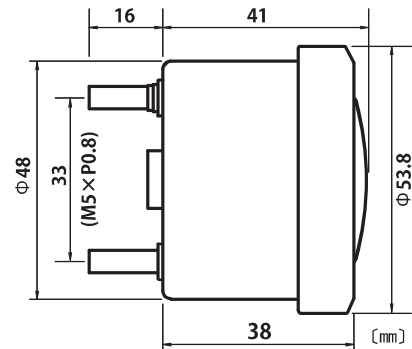



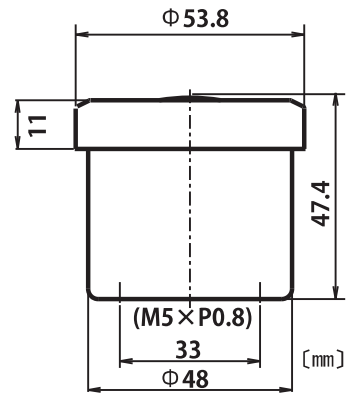



VELONA48



- Stainless-steel housing
- Incl. V-shaped bracket





■ SPEED (km/h or MPH)



-  200/260 km/h (MPH)
-  0-99,999.9km (mile)
-  1 & 2, 0-99,999.9km (mile)
-  DC 10.0-18.0V
-  Memory & Recall
-  Changeable backlit
White / Blue / Orange

■ RPM



-  9000rpm
-  DC 10.0-18.0V
-  Memory & Recall
-  with Red LED lamp
- Changeable backlit
White / Blue / Orange

■ Mount Kit for VELONA48 RPM







NEW



Digital Gauge CUBE



#80920

-  0-399km/h or 0-250MPH
-  0-10,000 or 20,000rpm
-  0-99,999km (mile)
-  1 & 2, 0-9,999.9km (mile)
-  DC 8.0-18.0V
-  RPM bar-scale
10,000 / 20,000rpm
-  Bar-graph blinking

- Aluminum housing, black anodized
- Compact size

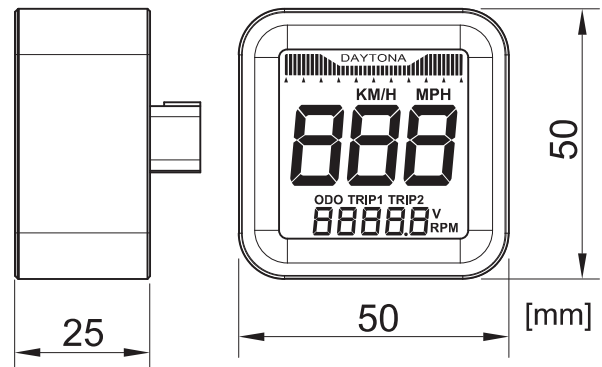

Multifunction Cockpit



■ DEVA



#89363

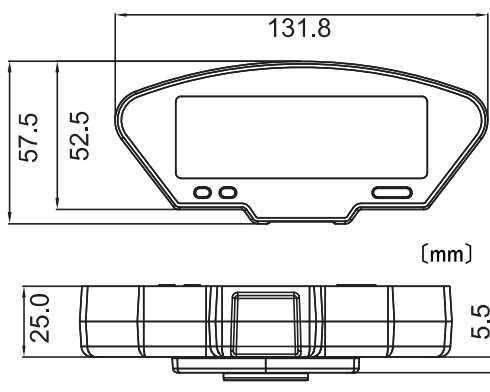

- ABS housing
- Incl. stainless-steel bracket
- Incl. magnetic speed sensor

- | | |
|--|--------------------------------|
| 0-399km/h or 0-250MPH | 0-10,000 or 20,000rpm |
| 0-99,999.9km (mile) | RPM bar-scale 10,000/20,000rpm |
| 1&2, 0-9999.9km (mile) | Memory & Recall |
| 0-99,999.9km (mile) Set start from any value | Bar-graph blinking |
| Memory & Recall | Fuel Gauge (100Ω,250Ω,510Ω) |
| 8.0-18.0V | 0°C ~ +150°C (+32°F ~ +356°F) |
| Low Battery Warning | 0°C ~ +150°C (+32°F ~ +356°F) |
| 12h or 24h | -10°C ~ +60°C (+14°F ~ +140°F) |
| N, 1, 2, 3, 4, 5, 6 Top 4/5/6 selectable | |
| | Indicators |

Option



■ ASURA



#84787

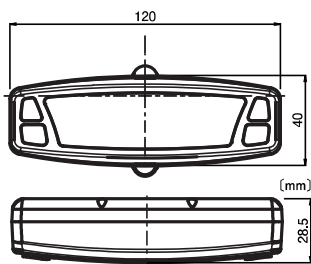

- ABS housing
- Incl. clamp for Φ22.2/25.4/31.8mm handlebars
- Incl. magnetic speed sensor

- | | |
|--------------------------------|---------------------------------|
| 0-399km/h or 0-250MPH | 0-20,000rpm |
| 0-99,999.9km (mile) | 1&2, 0-999.9km (mile) |
| -10°C ~ +60°C (+14°F ~ +140°F) | 40°C ~ +200°C (+104°F ~ +392°F) |
| Memory & Recall | Memory & Recall |
| 12h or 24h | Fuel Gauge |
| Low Battery Warning | Oil Changing Time Notification |
| | Indicators |

Option



#84851 Temp Sensor

NANO I

- 40(W)x60(L)x17.6(D)mm
- Without backlit
- Coin cell driven (CR2032)
- Unit detachable

■TEMP



#85995

- 0°C ~ +270°C (+32°F ~ +518°F)
- 0°C ~ +60°C (+32°F ~ +140°F)
- Low Battery Warning
- 12h
- Memory & Recall

※ Incl. R1/8 sensor

■RPM



#86719

- 0-20,000rpm
- Resettable & Non-resettable, 0-9,999.9hours
- 12h
- Memory & Recall

NANO II

- 40(W)x60(L)x22(D)mm
- White LED backlit
- Work on DC12V
- Clamp for Φ22.2/25.4mm handlebars

■SPEED



#86596

- 0-399km/h or 0-250MPH
- 0-999,999km (mile)
- 1 & 2, 0-99,999.9km(mile)
- 12h
- Memory & Recall

※ Incl. magnetic speed sensor

■GEAR



#86533

- N, 1, 2, 3, 4, 5, 6, 7, 8
Top 4/5/6/7/8 selectable
- Bar-graph blinking

Compact Gauge Series

■ Volt Meter



#89279



7.5 ~ 18.0V



Low voltage alert by Red LED backlight when less than 12V

- 25(W) x 42(L) x 10.8(D)mm
- White LED backlight
- Waterproof (IPX7)

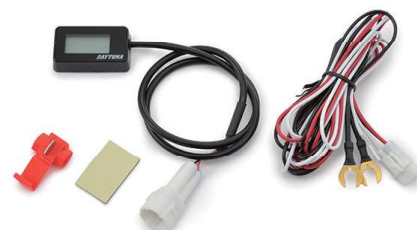
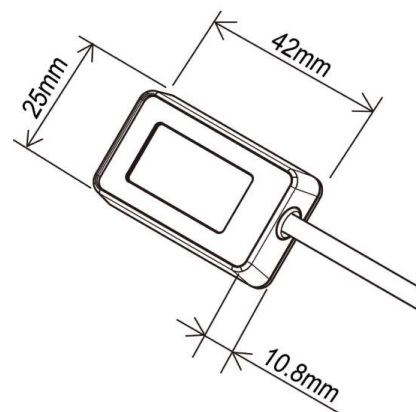

■ Wireless Hour Meter



#80072



0-999,999 hours 59minutes

- 36(W) x 57(L) x 17.3(D)mm
- No wiring connection required
- The battery included inside cannot be replaced
- Battery life approx. 4years
- Waterproof (IP68)

Gauge Options

■ Proximity Speed Sensor



“Non-contact” type speed sensor,
can generate electrical pulse signal from most vehicles.

Wire length : 2000mm
Max.current : 100mA

#87038

■ Speed Pulse Converters



Dia10 insert

TRIUMPH, HONDA,
BMW etc.
Wire length : 1280mm

#87755



Dia18 plug connection

YAMAHA SR400/500
etc.
Wire length : 1280mm

#87041



Dia15 insert

HONDA, SUZUKI etc.
Wire length : 1800mm

#87143



M12 thread female

YAMAHA, SUZUKI,
DUCATI, MOTO GUZZI
etc.
Wire length : 1200mm

#87429



For BMW

BMW boxer models
Wire length : 700mm

#88457

R65, R80, R100,
R100GS



Universal

Wire length : 650mm

#87430

OEM
SPEEDOMETER CABLE

■ RPM Induction Wire Set



For easy detection of
RPM pulse connecting
to spark plug wire or
to ignition coil

#87170

■ RPM Pulse Rectifier



For cases
that RPM pulse cannot
be detected well or
RPM signal is unstable

#92333

■ Temp Sensor (R1/8)

Wire length : 1000mm



#80228

■ Remote Control Switch



Operates VELONA gauges remotely instead of pressing bottom buttons.

- For $\Phi 22.2/25.4$ mm handlebars
- Wiring outside or inside handlebar possible
- Max. current capacity 50mA
- Width 12mm



Round type
#80918 BLACK
#80919 CHROME

Edge type
#87047 BLACK



■ Adjustable Bracket of VELONA-W, VELONA80, VELONA60



- mount pitch adjustable 63-112mm

■ Combinative Brackets for VELONA48



#87768



#87785

■ Anti-vibration Brackets for VELONA60



#61197

#63526



#63527

#63528

■ Combinative Brackets for VELONA60



#87404

#87403



#63529

LED Micro Indicator

■ GAMMA



#81068

- Aluminum body
- CNC Aluminum clamp for $\Phi 22.2/25.4$ mm handlebars
- Vertical & horizontal installation possible

3 interchangeable lenses!

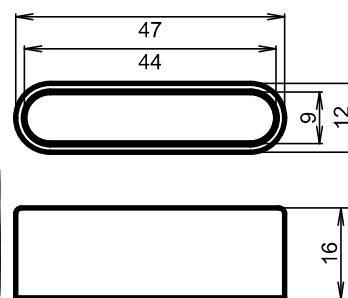

■ ALPHA



#86531 BLACK



#86532 CHROME

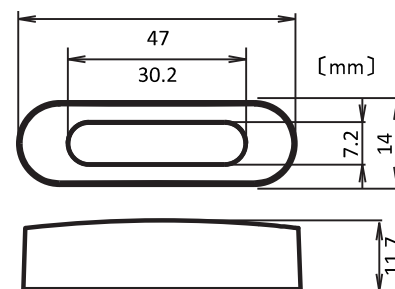

- ABS body
- Aluminum clamp for $\Phi 22.2/25.4$ mm handlebars
- Vertical & horizontal installation possible

D-Mirror-3

■ Aluminum Housing & Stem



#89428
Bar-end type
1PC



#89429
Standard type
1PC

D-Mirror-4

■ Aluminum Housing & Stem



#89430
Bar-end type
1PC



#89431
Standard type
1PC

D-Mirror-5



■ Aluminum Housing & Stem



#89474
Bar-end type
1PC



#89475
Standard type
1PC

D-Mirror-6



■ Aluminum Housing & Stem



#89722
Bar-end type (Short)
1PC

#89723
Bar-end type (Long)
1PC

■ Aluminum housing & steel stem



#89724
Standard type (Right)
1PC

#89725
Standard type (Left)
1PC



D-Mirror-7



■ Aluminum Housing & Stem



■ Aluminum housing & steel stem



#89726
Bar-end type (Short)
1PC

#89727
Bar-end type (Long)
1PC

#89728
Standard type (Right)
1PC

#89729
Standard type (Left)
1PC

D-Mirror-8



■ Aluminum Housing & Stem



■ Aluminum housing & steel stem



#89730
Bar-end type (Short)
1PC

#89731
Bar-end type (Long)
1PC

#89732
Standard type (Right)
1PC

#89733
Standard type (Left)
1PC

D-Mirror-9



■ABS housing & aluminum stem

■ABS housing & steel stem



#89813
Bar-end type (Short)
2PCS/SET

#89814
Bar-end type (Long)
2PCS/SET

#89815
Standard type
L/R SET

D-Mirror-10



■ABS housing & aluminum stem

■ABS housing & steel stem



#89816
Bar-end type (Short)
2PCS/SET

#89817
Bar-end type (Long)
2PCS/SET

#89818
Standard type
L/R SET

D-Mirror-11



■ABS housing & aluminum stem



#80715 LEFT (cowl type)
#80716 RIGHT (cowl type)



#80719 LEFT
#80720 RIGHT

D-Mirror-12



■ABS housing & aluminum stem



#80717 LEFT (cowl type)
#80718 RIGHT (cowl type)



#80721 LEFT
#80722 RIGHT

D-Mirror-13

■ABS housing & aluminum stem

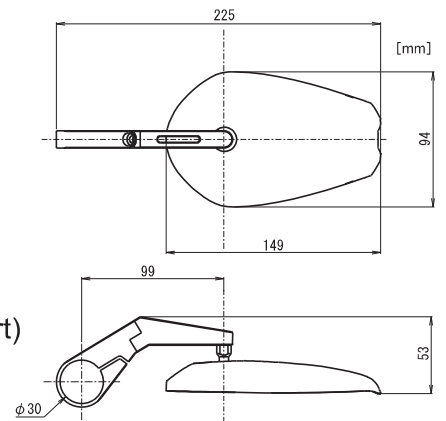

#80761
Bar-end type (Short)
1PC

D-Mirror-14

■ABS housing & aluminum stem

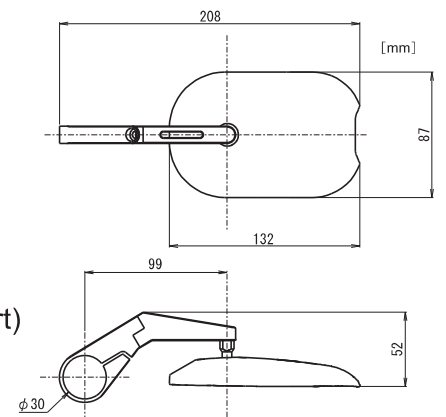

#80762
Bar-end type (Short)
1PC

D-Mirror-15



■Aluminum Housing & Stem



#80799 Bar-end type
1PC



Very flat housing!
4 ~ 6mm

D-Mirror-16



■Aluminum Housing & Stem



#80800 Bar-end type
1PC



D-Mirror-17



■Aluminum Housing & Stem



#80801 Bar-end type
1PC



D-Mirror-18

■ABS housing & Nylon stem



*Easily install
anywhere on the handlebar
without removing parts!*



#80917
Handlebar clamp type
1PC

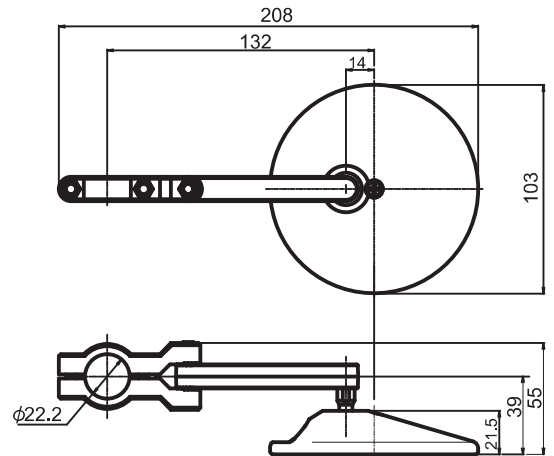

D-Mirror-19

■ABS housing & Nylon stem

*Ideal shape
for under the handlebar position,
hard to hit the tank
when turning the handlebar*



#81001
Handlebar clamp type
1PC

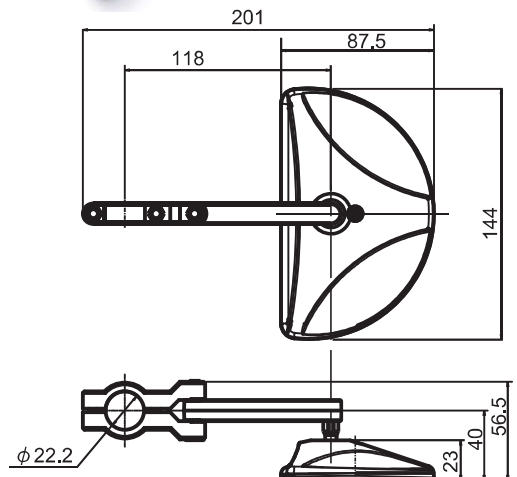

D-Mirror-20



■ Aluminum housing & stem



#80993 Left, 1PC
#80994 Right, 1PC

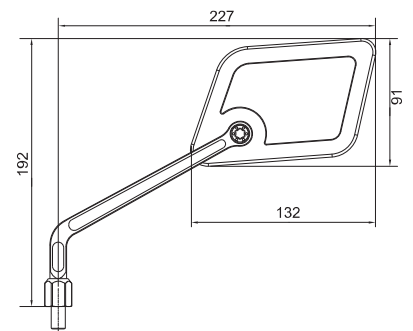

D-Mirror-21



■ Aluminum housing & stem



#80998 Left, 1PC
#80999 Right, 1PC

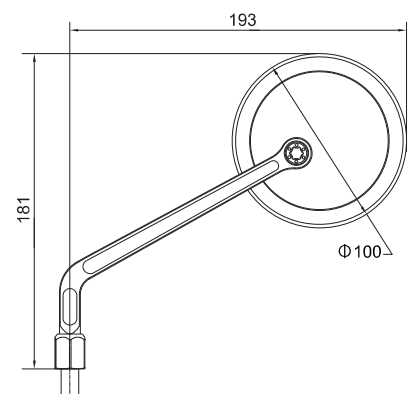

D-Mirror-22

■ Aluminum housing & stem



#81073
Bar-end type
1PC

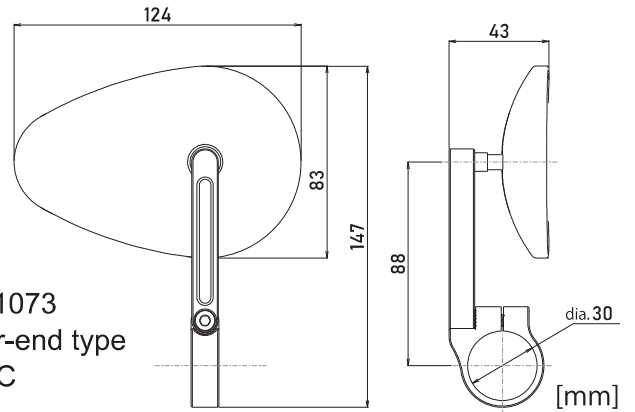

D-Mirror-23

■ Aluminum housing & stem



#81074
Bar-end type
1PC

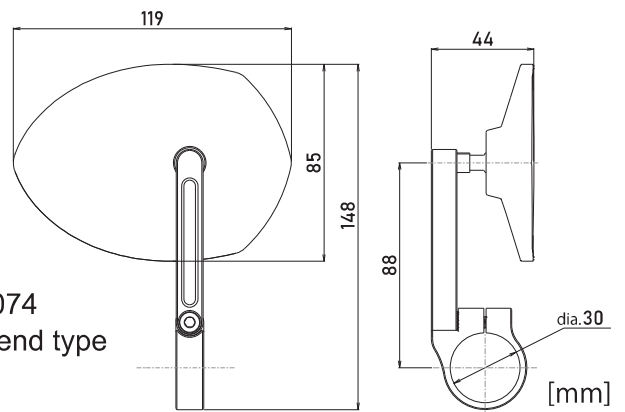

Mirror Adapters



- CNC Aluminum
- Mount area $\Phi 30 \times 12 \text{mm}$
- 2pcs/set

■ KAWASAKI



#89444

■ SUZUKI



#89443

■ YAMAHA-1



#89441

■ YAMAHA-2



#89442

■ BMW



#80863

■ UNIVERSAL for 22.2mm

*Please use adapter **A** for inner diameters between 13.5 ~ 16 mm and **B** for 16 ~ 19mm.



#89440

■ UNIVERSAL for inner diameters between 19 ~ 22.5mm



#80996

■ Adapter for HD

- UNF 5/16-24
- Steel
- 1pc



#87303

Mirror Hole Plug Bolt



- CNC Aluminum
- 1pc

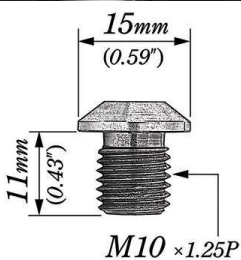

SIZE	RHS	LHS
RED	#99794	#99795
BLUE	#99796	#99797
GOLD	#99798	#99799
GREEN	#99800	#99801
SILVER	#99614	#99615
BLACK	#99616	#99617
TITANIUM	#99618	#99619



SIZE	RHS	LHS
BLACK	#80939	#80943
GUNMETAL	#80940	#80944
RED	#80941	#80945
ORANGE	#80942	#80946

LED Indicator

■D-Light MINI 1



#80758

- Zinc alloy body
- M8 bolt installation
- ECE approved for front and rear

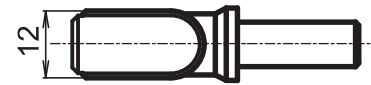
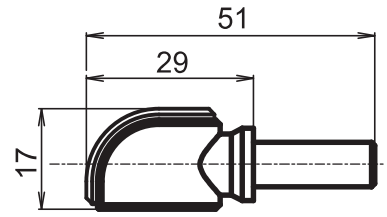

■D-Light MINI 2



#80825

- Zinc alloy body
- M8 bolt installation
- ECE approved for front and rear

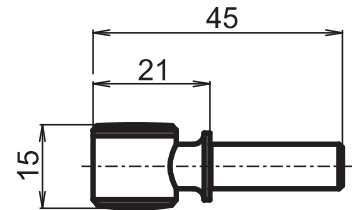

■D-Light MINI 3



#80826

- Zinc alloy body
- M8 bolt installation
- ECE approved for front and rear

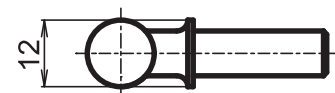
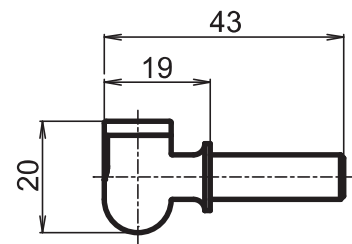

■D-Light SOL 2 

NEW

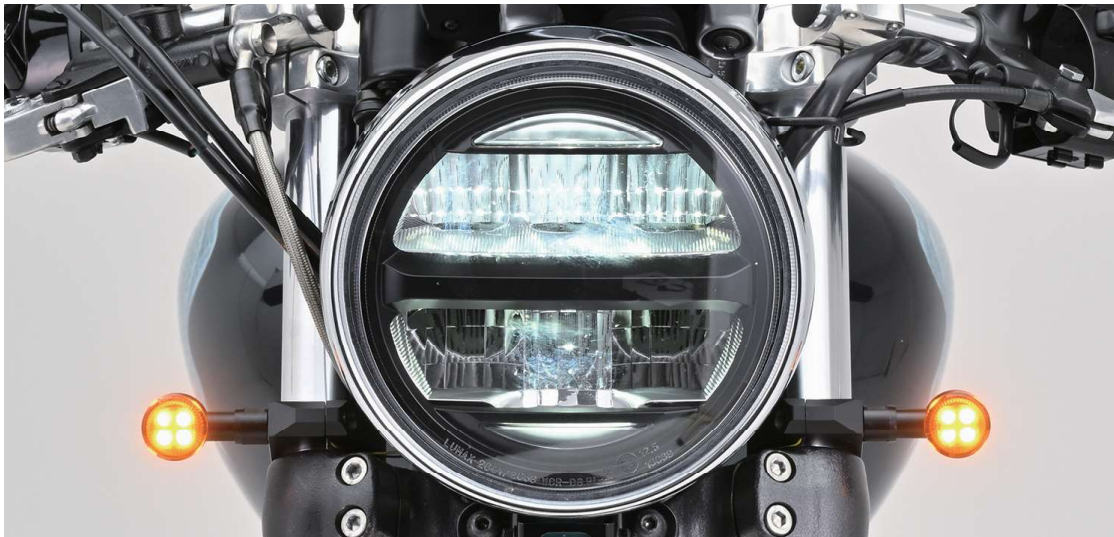

#81247 ORANGE LENS



#81248 SMOKE LENS

- CNC Aluminum body
- M8 bolt installation
- ECE approved for front and rear

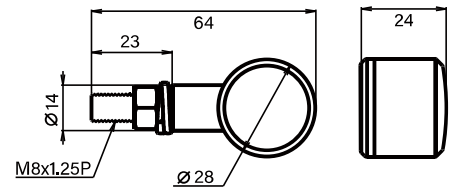

■D-Light STELLAR 



#88266

- Aluminum body
- M8 bolt installation
- ECE approved for front and rear
- Sequential lighting

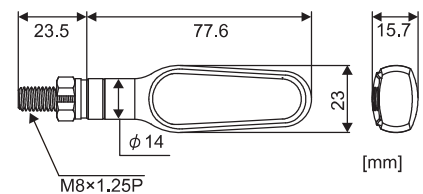

■D-Light RAY 

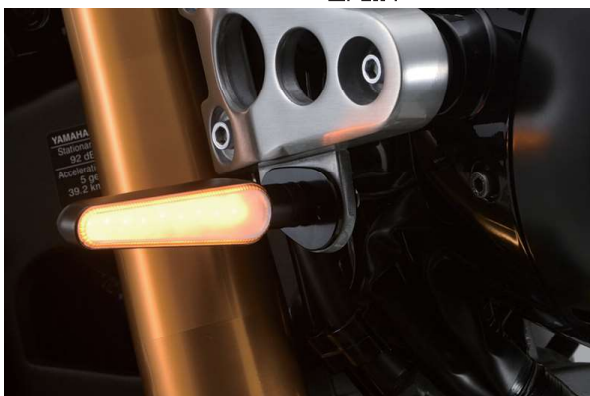

#89273

- Aluminum body
- M8 bolt installation
- ECE approved for front and rear
- Sequential lighting

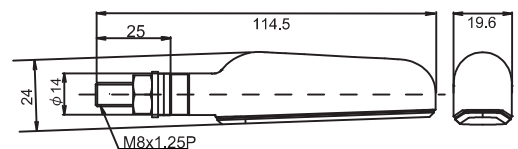

■D-Light CLASSIC 



- #81043
- Aluminum body
 - M8 bolt installation
 - ECE approved for front and rear

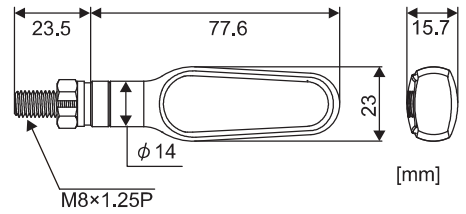

■D-Light SOL 



#88703
ORANGE LENS



#88731
SMOKE LENS

- Aluminum body
- M8 bolt installation
- ECE approved for front and rear

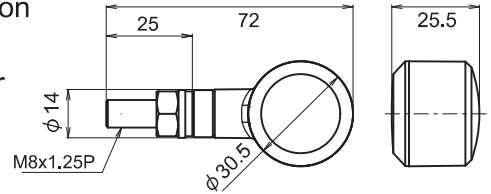

■D-Light SOL-W  



#89275
SMOKE LENS

- Aluminum body
- M8 bolt installation
- ECE approved for rear indicator and stop & tail
- 3 in 1

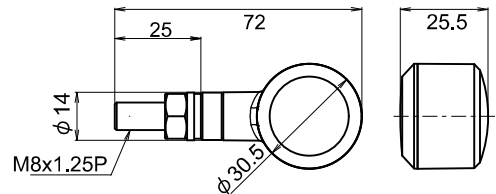

IC Relay

■10P for HONDA, hazard & position & ESS

NEW



#81442

- Power : DC8-16V (regular 12V)
- Power range : 0.1 ~ 100W
- Direction flashes : 85 count/minutes
- Hazard flashes : 85 count/minutes
- ESS flashes : 220 count/minutes
- Position light canceller
- CE approved

For CB650R/CBR650R(2024), CB125R (2024), CBR500R(2024), NX500 (2024), Hornet 500[CB500HORNET] (2024) etc..

■HONDA 8P, hazard & position & ESS



#89658

- Power : DC8-16V (regular 12V)
- Power range : 0.1 ~ 100W
- Direction flashes : 85 count/minutes
- Hazard flashes : 85 count/minutes
- ESS flashes : 220 count/minutes
- CE approved

For CB500F(2019-2023), CB650R(2019-2022), CBR650R(2019-2023), CB1000R(2018-2020), CMX250/300/500 REBEL(2020-2022), CMX1100 REBEL(2021-2022) etc..

■Universal



#88985

- Power : DC8-16V (regular 12V)
- Power range : 0.1 ~ 100W
- Size : 38×28.4×17.5mm
- Flashes : 85 count/minutes
- Incl. convertible connector (2P→3P)
- CE approved

■Universal, hazard & position



#89460

- Power : DC8-16V (regular 12V)
- Power range : 0.1 ~ 100W
- Size : 38×28.4×17.5mm
- Flashes : 85 count/minutes
- CE approved

Options for Direction Indicator

■ Fork Clamp for Indicator Mount



- CNC aluminum
- For M8 indicator
- Inside groove for discreet wiring

- #89855 Φ35mm
- #89856 Φ39mm
- #89857 Φ41mm
- #89858 Φ43mm
- #89859 Φ47mm
- #89860 Φ48mm
- #89861 Φ49mm
- #89862 Φ53mm
- #89863 Φ57mm
- #89864 Φ59mm



■ Extension



#81045



- CNC aluminum
- For M8 indicator (M8 in → M8 out)
- Outer diameter 13mm
- Length 30mm
- Sold by set (2pcs)

■ Mounting Plates



#81065 BMW



#97235 KAWASAKI



#97238 HONDA



#97398 SUZUKI



#97420 YAMAHA, KAWASAKI



#86963 SUZUKI



#86964 SUZUKI



#86965 KAWASAKI



#86987 HONDA



#86988 YAMAHA



#86989 YAMAHA

■ Adapter Collar M10



#86994

Headlight

■ CAPSULE120



- LED headlight
- Steel housing
- Dia. 120mm lens
- Front Position Lamp (ring)

SIDE-MOUNT

- #88633 BLACK
- #88634 CHROME

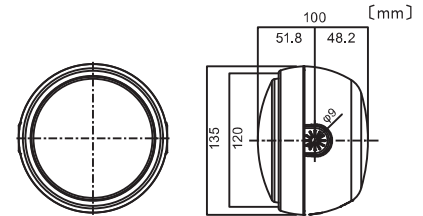

BOTTOM-MOUNT

- #88635 BLACK
- #88636 CHROME

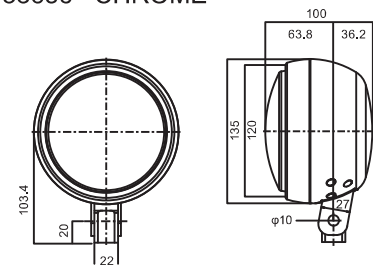

■ NEO VINTAGE



- LED headlight
- Steel housing
- 5-3/4" (146mm) lens
- Daytime Running Light (center-bar)
- Front Position Lamp (ring)
- With a hole for $\Phi 60$ mm gauge installation

- #88431 BLACK
- #88432 CHROME

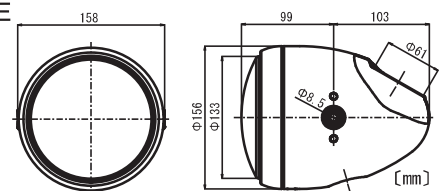

■ VINTAGE



- Steel housing
- 5-3/4" (146mm) lens
- H4 12V 60/55W bulb with T10 5W position light
- With a hole for $\Phi 60$ mm gauge installation

- #86903
RHS, BLACK

- #86904
RHS, CHROME

- #87357
RHS, BLACK & BLACK



#86982
U-shape bracket
for installation of VELONA60

Headlight Brackets

■Dual-axis Adjustable Type



- #80725 for $\Phi 35\text{mm}$
- #80726 for $\Phi 39\text{mm}$
- #80727 for $\Phi 41\text{mm}$
- #80728 for $\Phi 49\text{mm}$

● Material : CNC aluminum



● The fork clamp can be adjusted vertically, allowing the headlight position to be adjusted in the front-back direction.

● M8 indicator mount kit is included



■Modern Type

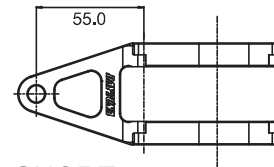

SHORT

- #88622 for $\Phi 35\text{mm}$
- #88623 for $\Phi 39\text{mm}$
- #88624 for $\Phi 41\text{mm}$
- #88625 for $\Phi 43\text{mm}$
- #88626 for $\Phi 49\text{mm}$

● Material : CNC aluminum

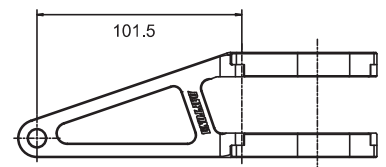

LONG

- #88617 for $\Phi 35\text{mm}$
- #88618 for $\Phi 39\text{mm}$
- #88619 for $\Phi 41\text{mm}$
- #88620 for $\Phi 43\text{mm}$
- #88621 for $\Phi 49\text{mm}$



#88624



#88619

LED Taillight

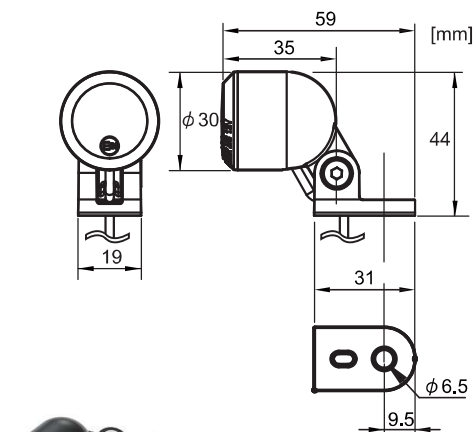

#80930

- Housing & bracket material : zinc alloy
- Fixing hardware material : stainless-steel
- ECE approved for stop & tail light
- M6 bolt installation
- Mounting angle adjustable

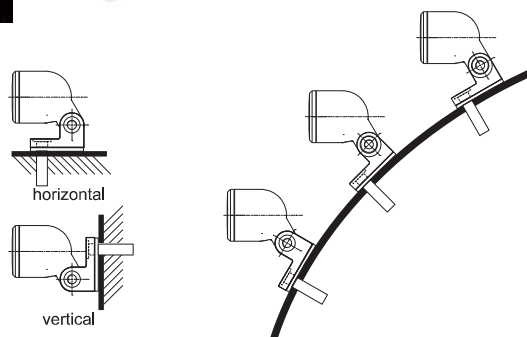

LED License Plate Lamp

- ECE approved



#88857

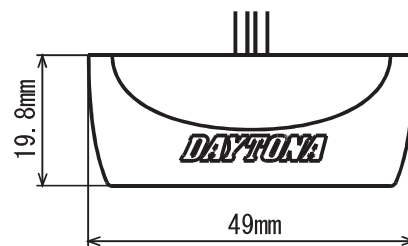

Slim Reflector

- Reflector area 100 x 13mm



#87192 Bolt-on

#87193 Tape-down

Universal ON / OFF Switch

■ Slim Type

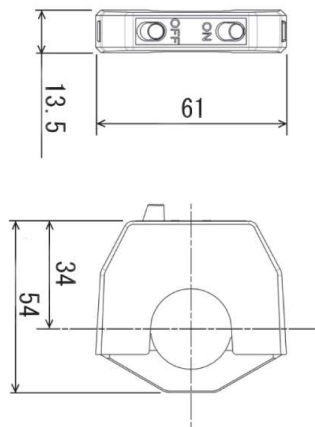

- Max. current 15A (12V-180W, 6V-90W)
- For $\Phi 22.2/25.4$ mm handlebars
- Housing material: nylon
- Wire length: 800mm



#88159 Flat Seesaw Type



#88160 Toggle Type

■ For H4 Headlight



#88162 Flat Seesaw Type



- Max. current 15A (12V-180W, 6V-90W)
- For $\Phi 22.2/25.4$ mm handlebars
- Housing material: nylon
- For H4 bulb only
- Wire length: 900mm

■ Slide Type



#71779 BLACK



#40440 YELLOW

- Size : 20×35×17mm (12V-180W, 6V-90W)
- 12V/6V
- 100W
- Wire length: 800mm

Smartphone Holder

■ SMARTPHONE HOLDER 3



#80218 RIGID TYPE (bolt-mount clamp)

#80219 DETACHABLE (quick-release clamp)

- Width adjustable 55 ~ 85mm
- Length adjustable 123 ~ 170mm
- Depth for 6 ~ 18mm
- Weight for up to 300g
- Clamp for $\Phi 22 \sim 29$ mm handlebars

DETACHABLE
(quick-release clamp)



RIGID TYPE
(bolt-mount clamp)

■ SMARTPHONE HOLDER 1



#87963 RIGID TYPE (bolt-mount clamp)

#87964 DETACHABLE (quick-release clamp)

- Width adjustable 55 ~ 85mm
- Length adjustable 110 ~ 147mm
※using additional arm : over 153mm possible
- Depth for 6 ~ 18mm
- Weight for up to 300g
- Clamp for $\Phi 22 \sim 29$ mm handlebars



TYPE-A



#89371

Slim-mount USB "TYPE-A" × 1 port

- Input : DC12V
- Output : DC5V
- Rated current : 2.4A
- Housing : ABS resins
- For 22.2mm/ 25.4mm handlebars
- Powers on with ignition key
- CE approved

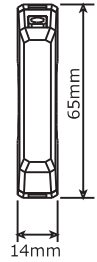

TYPE-A



#89372

Slim-mount USB "TYPE-A" × 2 port

- Input : DC12V
- Output : DC5V
- Rated current : 2.4A × 2 port
- Housing : ABS resins
- For 22.2mm/ 25.4mm handlebars
- Powers on with ignition key
- CE approved

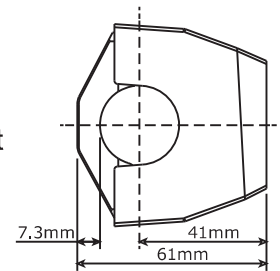

TYPE-A



#80729

USB "TYPE-A" × 1port

- Input : DC12V
- Output : DC5V
- Rated current : 2.4A
- Powers on with ignition key
- CE approved



TYPE-A



#80730

USB "TYPE-A" × 2 port

- Input : DC12V
- Output : DC5V
- Rated current : 2.4A × 2 port
- Powers on with ignition key
- CE approved



TYPE-C



#80399

USB "TYPE-C" × 1 port

- For USB PD (Power Delivery)
- Input : DC12V
- Output : 5V/3A, 9V/2A, 12V/1.5A
- Max : 18W
- Powers on with ignition key
- CE approved

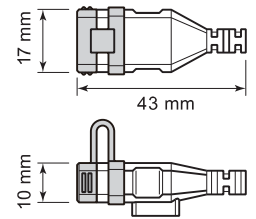

TYPE-C



#80400

Slim-mount USB "TYPE-C" × 1 port

- For USB PD (Power Delivery)
- Input : DC12V
- Output : 5V/3A, 9V/2A, 12V/1.5A
- Max : 18W
- For 22.2mm/ 25.4mm handlebars
- Powers on with ignition key
- CE approved

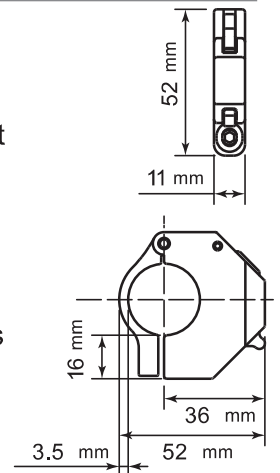

TYPE-C



#80992

USB "TYPE-C" × 1 port

- Aluminum housing & nut
- For USB PD(Power Delivery)
- Input DC12V
- Output 5V/3A, 9V/2A, 12V/1.5A
- Max.18W
- Powers on ignition key
- Green LED indicator when charging
- CE approved

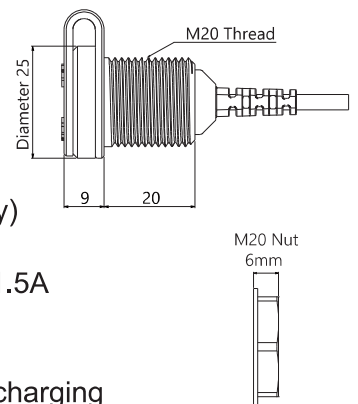

TYPE-C

#80967

USB "TYPE-C" × 1 port

- Aluminum housing
- For USB PD(Power Delivery)
- Input DC12V
- Output 5V/3A, 9V/2A, 12V/1.5A
- Max.18W
- For 22.2/25.4mm handlebars
- Powers on with ignition key
- CE approved

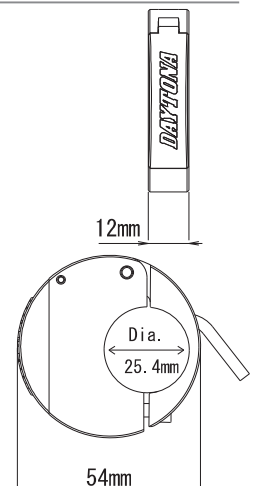

USB Cable for Motorcycle



- #80468 TYPE-C to TYPE-C
- #80469 TYPE-C to Lightning
- #80470 TYPE-A to TYPE-C
- #80471 TYPE-A to Lightning

- L-shaped
- Wire length : 20cm
- 18W (5V/3A, 9V/2A, 12V/1.5A)
- #80469 & #80471 with MFi approval

Smartphone DIRECT Charging Cable



- #15644 TYPE-C
- #15645 Lightning

- L-shaped
- Wire length : 800mm (from Connector to connector)
- LED lamp
- Powers on with ignition key
- #15645 with MFi approval

POWER

DAYTONA "DIRECT" charging cable



Mount Bar Holder

- Creates space for smartphone, navigation, USB power supply or switch etc.
- Bar diameter 22.2mm

■ Master Cylinder Clamp Type



- #92746 BLACK, 100mm
- #77435 BLACK, 155mm
- #77434 CHROME, 155mm

■ Master Cylinder Clamp Flat Type



- #92801 BLACK, 100mm
- #92802 CHROME, 100mm

■ Handle Clamp Type



- #92748 BLACK, 100mm
- #92747 CHROME, 100mm
- #77437 BLACK, 155mm
- #77436 CHROME, 155mm

■ Mirror Clamp Type



- #78031 BLACK, 100mm
- #78030 CHROME, 100mm

Free Combination Handle Brace



Adapter bar : 50mm



Bar : L200mm / L250mm



Clamp (pair)

For	Bar		Clamp Φ22.2mm	Adapter bar 50mm
	200mm	250mm		
RED	#99427	#99433	#99440	#99469
BLUE	#99428	#99434	#99441	#99470
GOLD	#99429	#99435	#99442	#99471
GREEN	#99430	#99436	#99443	#99472
SILVER	#99431	#99437	#99444	#99473
BLACK	#99432	#99438	#99445	#99474

Handlebar Bracket



#97253 BLACK

#98516 SILVER

#77791

- Aluminum handle clamp bracket
- For $\Phi 22.2$ mm handlebar
- Plate 40 x 40mm
- Angle adjustable

- ABS handle clamp bracket
- For $\Phi 22.2/25.4$ mm handlebars
- Plate 34 x 35mm

■ Type B

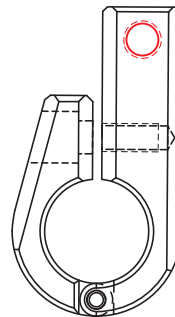

- #68453 : M8, 7/8" (22.2mm)
- #68459 : M8, 1" (25.4mm)
- #68456 : M10, 7/8" (22.2mm)
- #68462 : M10, 1" (25.4mm)



■ Type C

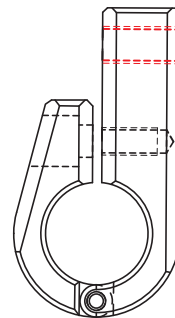

- #68454 : M8, 7/8" (22.2mm)
- #68460 : M8, 1" (25.4mm)
- #68457 : M10, 7/8" (22.2mm)
- #68463 : M10, 1" (25.4mm)



Heated Grips

■ Built-in Switch, 4-level Heat Control

#88640



4-level Heat Control
For $\Phi 22.2\text{mm}$ (7/8") motorcycles
Open end



#89820



4-level Heat Control
For $\Phi 22.2\text{mm}$ (7/8") motorcycles
Open end



★ Battery Protection

※ automatically turned off
when voltage is less than 12V



#81044

4-level Heat Control
For $\Phi 22.2\text{mm}$ (7/8") motorcycles
Open end



■ Built-in Switch, 3-level Heat Control



#87407
For $\Phi 22.2\text{mm}$ (7/8"), Open end



#88019
For $\Phi 25.4\text{mm}$ (1")
Closed end

#88020
For Harley Davidson
(96UP, 08UP)
Closed end



■ 4-level Heat Control



#88987
For $\Phi 22.2\text{mm}$ (7/8"), Open end

#88988
For ATVs, Open end



#86610
For $\Phi 25.4\text{mm}$ (1"), Closed end



■ Spare Switch



#86983
orange button



#89650
black button w/clamp kit

■ Thumb warmer



#89875
For ATV Heated Grips (#88988)

■2-level Heat Control



#86607
For $\Phi 22.2\text{mm}$ (7/8")
Closed end

■Spare Switch

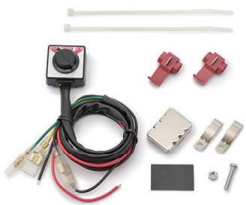

#24050

■Glue

NEW



#81282
Glue for heated grips, GORILLA

- Heatproof temperature 93°C
- 3g/pc for left & right grips

Grip Warmer



#80583

- 12V
- Size : 105×95mm
- ON/OFF switch
- Wrap type

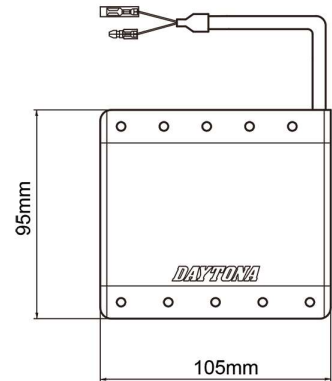

**Easy mount on grip!
Only use when cold!**

GrippyGrip

■GGD-CLASSIC (Φ22.2mm/L122mm)



#33448
BLACK



#33513 BROWN #33520 RUBBER-LIKE

■GGD-VINTAGE (Φ22.2mm/L122mm)



#33445
BLACK



#33446 BROWN #33447 RUBBER-LIKE

■GGD-KNIT (Φ22.2mm/L122mm)



#33432
BLACK



#33440 BROWN #33444 DARK RED

■GGD-GRID (Φ22.2mm/L122mm)



#32727
BLACK

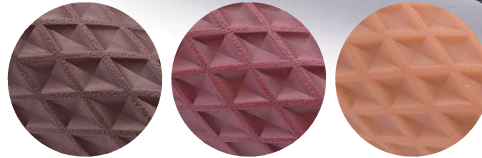

#32728 BROWN #32729 DARK RED #32731 RUBBER-LIKE

■GGD-BASE (Φ22.2mm/L125mm)



#88217
BLACK



#88218 GRAY #88219 BROWN

■GGD-DELTA (Φ22.2mm/L123mm)



#88565
BLACK

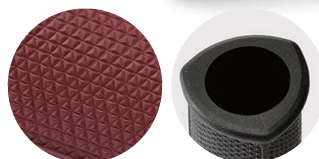

#88567 DARK RED

■GGD-NAMI (Φ22.2mm/L125mm)



#88561
BLACK



#88562 BROWN #88563 DARK RED

■GGD-KANI (Φ22.2mm/L125mm)



#88937
BLACK

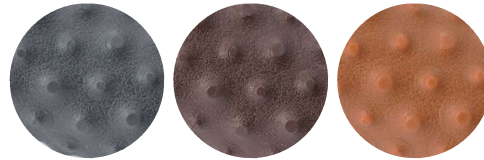

#88938 GRAY #88939 BROWN #88940 CARAMEL

■GGD-AMI (Φ22.2mm/L125mm)



#88569
BLACK



#88613 GRAY #88570 BROWN #88614 DARK BLUE #88615 DARK GREEN #88571 DARK RED

■GGD-SAKURA (Φ22.2mm/L125mm)



#88942
BLACK



#88943 GRAY #88944 CARAMEL

■GGD-NINJA (Φ22.2mm/L125mm)



#88663
BLACK



#88664 GRAY #88665 BROWN #88666 DARK RED

■GGD-LINE (Φ22.2mm/L125mm)



#88658
RED



#88659 BLUE #88660 GREEN #88661 YELLOW #88769 GRAY

■GGD-KATANA (Φ22.2mm/L125mm)



#88573
RED



#88574
BLUE

#88575
GREEN

#88579
WHITE

#88576
GRAY

■GGD-CELL (Φ22.2mm/L125mm)



#88669
RED



#88670
BLUE

#88671
GREEN

#88673
DARK GREEN

#88672
GRAY

■GGDM-BASE (Φ22.2mm/L125mm)



#80912
BLACK × SILVER



#80913
BROWN × SILVER

■GGDM-CROSS (Φ22.2mm/L125mm)



#80914
BLACK × BLACK



#80915
BLACK × SILVER

■GGDI-BASE (Φ25.4mm/L125mm)



#89746
BLACK



#48044
BROWN

NEW
Color

■GGDI-KAWA (Φ25.4mm/L125mm)



#89747
BLACK



#48046
BROWN

NEW
Color

■GGDI-GRID (Φ25.4mm/L127mm)

NEW



#47826
BLACK



#47893 BROWN #47897 OXBLOOD RED

■GGDI-KNIT (Φ25.4mm/L127mm)

NEW



#47825
BLACK



#47901 BROWN #47903 OXBLOOD RED

■GGDI-ARC1 (Φ25.4mm/L125mm)



#88667

■GGDI-ARC3 (Φ25.4mm/L125mm)



#88675

■GGDI-OCTA (Φ25.4mm/L125mm)



#88674

■Grip Spacer



Before

fills the gap ↓



After

#80561

- Material : Neoprene
- O.D. : 50mm
- I.D. : 22 or 26mm
- Thickness : 5mm
- 2pcs/set

Throttle Sleeve

NEW



#77240 HONDA-0



#29453 HONDA-1



#29778 HONDA-2

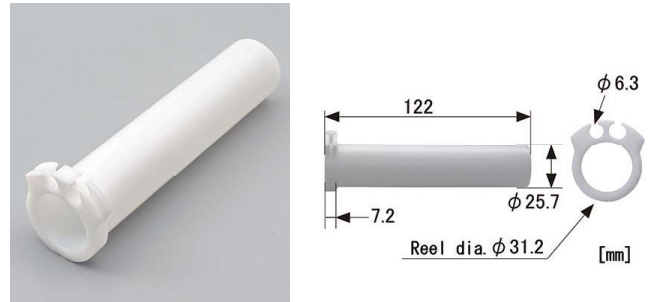

#70673 YAMAHA-0



#29456 YAMAHA-1



#29733 YAMAHA-2



#70360 SUZUKI-0



#29470 KAWASAKI-1



#29479 KAWASAKI-2

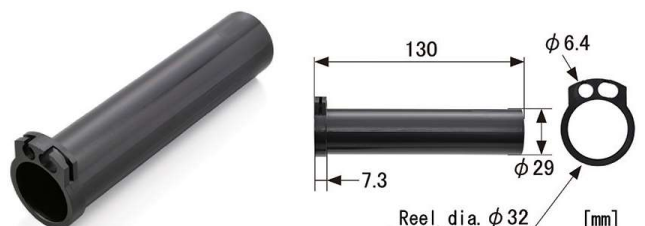

#42577 Universal

Master Cylinder Tank Cap



■ For BMW



#80834



#80836



#80838



#80835



#80837



#80839



#80840

- #80834 R1250GS, R1200GS
- #80836 R1250GS, R1200GS
- #80838 R1250GS, R1200GS
- #80835 R NINE T, F850GS
- #80837 R NINE T
- #80839 R NINE T
- #80840 F850GS

- Double color anodized
- CNC Aluminum
- Use OEM diaphragm
- Patented design

■For KAWASAKI, **Z650, Z900 etc.**



#80634 GREEN



#80635 BLACK

■For HONDA, **MONKEY125**



- #80814 BLACK
- #80815 BLUE
- #80816 RED
- #80817 GOLD

■For HONDA, **GROM, CB650R etc.**



#80818 BLACK

■ For NISSIN



#80636 GREEN Φ42



#80637 BLACK Φ42

■ For NISSIN



SIZE	Φ38	Φ42	Φ59
RED	#92737	#92732	#92727
BLUE	#92738	#92733	#92728
GOLD	#92739	#92734	#92729
GREEN	#92740	#92735	#92730
SILVER	-	#92736	-

Oil Filler Cap



#80638 GREEN
M20×P2.5



#80639 BLACK
M20×P2.5



SIZE	M20× P2.5	M24× P3.0
RED	#98399	-
BLUE	#98400	#98406
GOLD	#98401	#98407
GREEN	#98402	-
SILVER	#98403	#98409
BLACK	#98404	-

Handlebar End Plug

NEW

■ "RING"



Can also be used as a bar-end mirror adapter.



- For I.D. 14-19mm
- Outer Diameter 31
- Double function
- Mirror mounting area $\Phi 30$

#81228 BLACK
#81229 CHROME

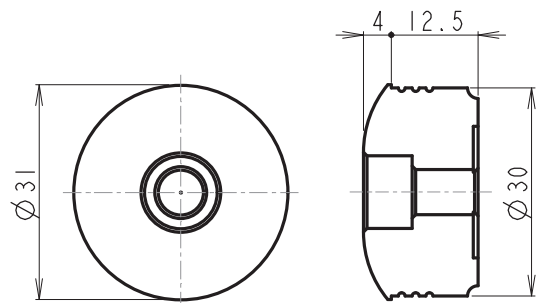

■ "W"



- For I.D. 14-19mm
- Outer Diameter 31
- Double function
- Mirror mounting area $\Phi 30$

#81174 BLACK
#81175 RED
#81176 ORANGE

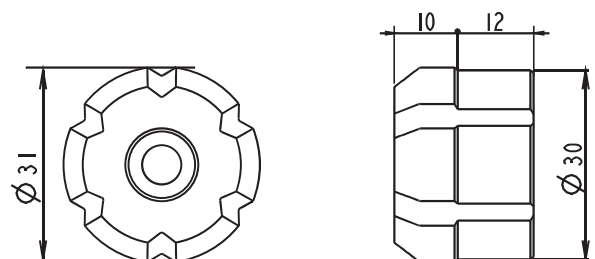

■ “TKM-2”

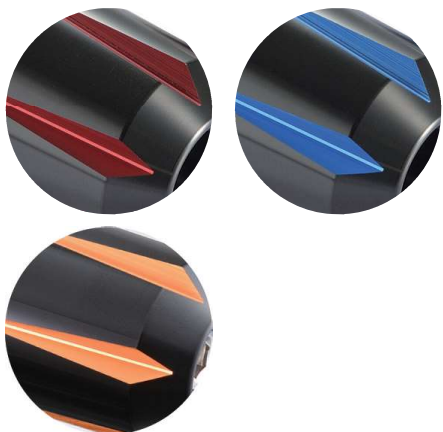

- For I.D. 14-19mm
- Outer Diameter 30mm
- Dual Anodizing

#87331 RED
 #87332 BLUE
 #88059 ORANGE



■ “COMPASS”



- For I.D. 14-19mm
- Outer Diameter 30mm

#80897 RED
 #80898 BLUE
 #80899 SILVER
 #80900 ORANGE



■ “BULLET”



- For I.D. 14-19mm
- Outer Diameter 30mm

#80911 GUNMETAL
 #98374 BLACK



■ “PINO-3”



- For I.D. 14-19mm
- Outer Diameter 30mm

#99981 : RED
 #99982 : BLUE
 #99983 : CHAMPAGNE
 #99984 : GREEN
 #99985 : SILVER
 #99986 : BLACK



Crash Pad

NEW



- L/R set
- Shock-absorbent PE pad
- Anodized aluminum cap



#81287	YAMAHA	MT07 (2014-), XSR700 (2016-), Tracer700 (2016-2020), R7 (2023-)
#81079	KAWASAKI	Z900 (2017-)
#81345	KAWASAKI	Z650 (2017-), Ninja650 (2017-), Z650RS (2021-)
#81346	HONDA	CMX500 Rebel [S] (2017-), CL500 (2023-)
#81347	HONDA	CB650R (2019-2023)

Aluminum Meter Visor



NEW



Material : Aluminum

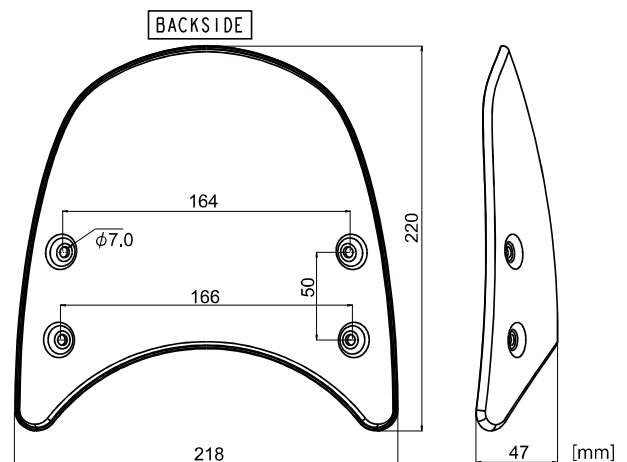

■Bracket



#81350
BMW
R NINET



#81470
HONDA
CB650R(19-23)



#81471
HONDA
CMX500(17-19)

NEW



#81472
HONDA
CMX500(20-23)



#81473
HONDA
DAX125(23)
MONKEY(18-22)



#81474
YAMAHA
XSR900(22)



#81439
YAMAHA
SR500(78-08)
SR400FI(10-21)



#81475
KAWASAKI
W800(11-16)



#81476
KAWASAKI
W650(99-08)



#81477
KAWASAKI
Z900RS(18-22)



#81411
TRIUMPH
BONNEVILLE



HenlyBegins Seat Bag

※HenlyBegins is a brand owned by Daytona Japan.



- ① #96719 (Black) / ⑤ #29783 (Khaki) 20 ~ 26 ℓ W(300 ~ 400)×D300×H200mm Loading Weight 7kg
- ② #96720 (Black) / ⑥ #29784 (Khaki) 33 ~ 42 ℓ W(490 ~ 610)×D275×H225mm Loading Weight 8kg
- ③ #96721 (Black) / ⑦ #29785 (Khaki) 44 ~ 60 ℓ W(410 ~ 570)×D320×H300mm Loading Weight 10kg
- ④ #97980 (Black) / ⑧ #29786 (Khaki) 53 ~ 70 ℓ W(525 ~ 685)×D320×H300mm Loading Weight 14kg

- Polyester ● Incl. rain cover ● Expandable





#19437

DH-747 **5.5 ℓ**

- W220×D295×H165mm
- PC & Polyester
- Incl. rain cover
- Loading weight 5.5kg



#95741 (BLACK)
#95734 (CARBON × BLACK)
#95735 (RED)

DH-708 **4 ℓ**

- W250×D285×H110mm
- Artificial leather & Polyester
- Incl. rain cover
- Loading weight 5kg



#97087

DH-723 **6 ℓ**

- W250×D300×H185mm
- Artificial leather & Polyester
- Incl. rain cover
- Loading weight 5kg



#96043

DH-710 **7 ℓ**

- W235×D280×H145mm
- Artificial leather & Nylon
- Incl. rain cover
- Loading weight 5kg



#97241

DH-722 **7~12 ℓ**

- W250×D345×
H(150~220)mm
- Polyester ● Expandable
- Incl. rain cover
- Incl. shoulder strap
- Loading weight 5kg



#98661

DH-731 **13~26 ℓ**

- W280×D345×
H(190~310)mm
- Polyester ● Expandable
- Incl. rain cover
- Incl. shoulder strap
- Loading weight 5kg





NEW



#48147 (polyester)
#48148 (tarpaulin)

DH-768 / 769 **20 ℓ**

- W440×D300×H170mm
- Incl. rain cover
- Incl. easy ring belt
- Loading weight 5kg



NEW



#48385 (BLACK)
#48389 (GRAY)
#48390 (YELLOW)

#41380 (BLACK)
#48383 (GRAY)
#48384 (YELLOW)

DH-772 **40 ℓ**

DH-767 **60 ℓ**

- W530×D300×H270mm
- Loading weight 10kg
- Tarpaulin Fabric
- Incl. shoulder belt and fixing belt
- W550×D330×H350mm
- Loading weight 14kg
- Waterproof

Backpack



NEW



#41379 (BLACK)
#48379 (GRAY)
#48380 (YELLOW)

DH-766 **30 ℓ**

- Φ300×L450mm
- Tarpaulin Fabric
- Loading weight 7kg
- Waterproof
- Incl. shoulder belt and fixing belt

HenlyBegins Saddle Bag

※HenlyBegins is a brand owned by Daytona Japan.



#40412 LEFT



#40413 RIGHT

11 ℓ W420xD150xH245mm
Loading Weight 5kg



①



②



③



④



⑤



⑥



⑦



⑧



⑨



⑩

Loading Weight

9 ℓ	W360xD130xH200	5kg	①#96906 (DHS-1)
10 ℓ	W360xD260xH270	5kg	②#32679 (DHS-29), ③#32680 (DHS-30, DIAMOND)
12 ℓ	W420xD150xH245	5kg	④#40262 (DHS-36), ⑤#40263 (DHS-37, DIAMOND)
12 ℓ	W360xD10xH270	5kg	⑥#96907 (DHS-2), ⑦#24364 (DHS-21, DIAMOND)
13 ℓ	W280xD170xH300	5kg	⑧#18994 (DHS-18)
18 ℓ	W400xD150xH300	5kg	⑨#96909 (DHS-4)
22 ℓ	W430xD160xH320	5kg	⑩#18996 (DHS-19)

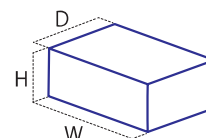

- Artificial leather & Polyester
- Incl. rain cover



#90557 **DHS-13** 10 l W350×D100×H280mm

Loading weight 2kg

#99702 **DHS-10** 15 l W365×D135×H320mm

Loading weight 2kg

● Polyester

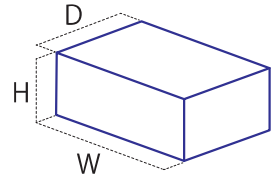

#99703 **DHS-11** 20 l W350×D100×H280mm

Loading weight 2kg each

#99704 **DHS-12** 30 l W360×D140×H315mm

Loading weight 2kg each

● Polyester



10 l W360×D120×H270mm
 ● Loading weight 2kg
 ● Polyester

#21774 **DHS-20** BLACK

#30849 **DHS-28** KHAKI

HenlyBegins Tool Bag

※HenlyBegins is a brand owned by Daytona Japan.



#98771 DHS-7 1.5 ℓ W250×D75×H105mm Loading weight 1.5kg

#98773 DHS-8 2 ℓ W255×D65×H130mm Loading weight 1.5kg

• Polyester

Under-seat Storage Pocket for Scooters



#93000
SMALL (250x320)

#93001
MEDIUM (270x320)

#93002
LARGE (270x400)

- For scooters
- Installation with tapping screws
- Storable weight 1kg



Daytona Outdoor

Compact & Light Camping Goods for Riders

MAEHIRO DOME DUO

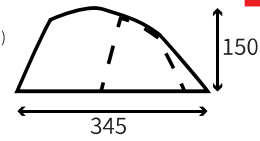
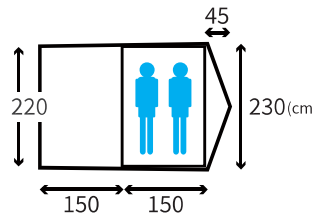

NEW



#42165

- W345×D230×H150cm
- Inner size 300×220cm
- Storage size 45×Φ20cm
- 4.2kg
- Nylon cover
- Aluminum pole

MAEHIRO DOME PLUS

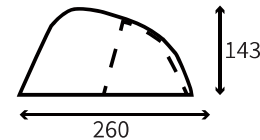
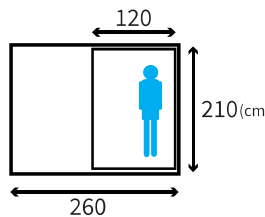

#48341

- W260×D220×H143cm
- Inner size 210×120cm
- Storage size 44×Φ18cm
- 3.7kg
- Nylon cover
- Aluminum pole

MAEHIRO SHELTER

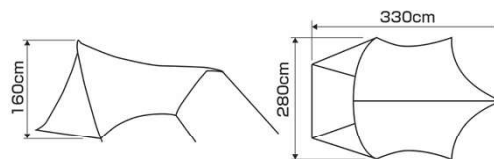

NEW

#44223

- W330×D280×H160cm
- Storage size 44×Φ10cm
- 1.35kg
- Nylon cover
- Aluminum pole



■ Aluminum pole (option)

#46302

- 100cm



■ **Ground Sheet**



#46250

NEW

- for tent (#42165)
- 220×150cm
- Storage size 18×21cm
- 300g
- Polyester



#39569

- for tent (#48341)
- 210×120cm
- Storage size 18×21cm
- 240g
- Polyester

■ **Aluminum Forged Peg**

NEW



- #37028
- 200mm
 - 53g



- #37800
- 300mm
 - 75g

■ **Peg Hammer**

NEW



#48208 BK-STL

- W3×D5×H25cm
- 550g
- Head: Steel
- handle : Beech tree

#48206 BR-SUS

- W3×D5×H25cm
- 550g
- Head: Stainless steel
- handle : Walnut



■ **Chisel**

NEW



#39610

- W6.5×D1.5×H15cm
- 390g
- Steel



■Inflatable Mat



① #35467 (thickness 3.5cm)

② #46247 (thickness 5.0cm)

NEW

- W183×D53cm
- Storage size (①Φ14.5×27 / ②Φ17×27cm)
- Weight (①680g / ②880g)
- Detachable cushion
- Nylon

■Air pillow



#34251

- 42×27cm
- Storage size 11×17cm
- 72g
- Polyester



■Barbecue Grill



#16374

- Foldable Design
- W23.7×D17.8×H17.5cm(Unfolded)
- Storage size W23.5×D18×H2.5cm
- 1950g
- Stainless Steel

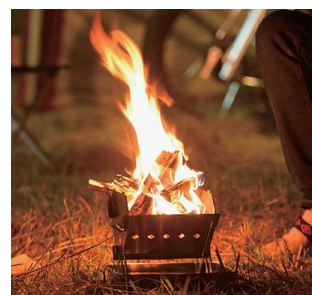

■ Foldable Table

NEW



#37539

- W40×D34×H36cm
- Storage size W47×D10×H12cm
- 1100g
- Up to 30kg of weight
- Aluminum

■ Sierra Cup

NEW



#48326

- Φ12×16.5×4.5cm
- 95g
- Stainless steel



■ Square Kettle

NEW



#37008

- W14.7×D14.7×H5.6cm
- 220g
- Capacity 450ml
- Body: Aluminum / Handle: stainless steel / Handle cover: silicon / Lid handle: brass



Connector & Terminal Set



TYPE110
 #96167 (2-pole)
 #96168 (3-pole)
 #96169 (4-pole)
 #96170 (6-pole)
 #96171 (9-pole)

#96167



TYPE250
 #96172 (2-pole)
 #96173 (3-pole)
 #96174 (4-pole)
 #96175 (6-pole)

#96172



TYPE HM
 #96182 (2-pole)
 #96183 (3-pole)
 #96184 (4-pole)
 #96185 (6-pole)

#96182



**TYPE HM
 [waterproof]**
 #96176 (2-pole)
 #96177 (3-pole)
 #96178 (4-pole)
 #96179 (6-pole)

#96176



**TYPE MT
 [waterproof]**
 #96180 (3-pole)
 #96181 (4-pole)

#96180

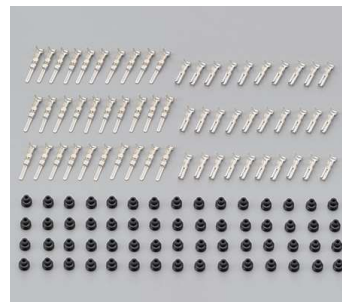

**Terminal Set for
 HM/MT waterproof
 connector**
 Male terminal x 30
 Female terminal x 30
 Wire seal x 60

#96303



Bullet Terminal Set
TYPE CA/CB103
 #96153 Set of 30
 #96155 Set of 5
TYPE CA/CB104
 #96156 Set of 30
 #96157 Set of 5
 For KAWASAKI
 #96158 Set of 30



**Bullet Terminal Set
 [waterproof]**
TYPE CA/CB103
 #41220 Set of 20
 #61938 Set of 5
TYPE CA/CB104
 #41221 Set of 20
 #61939 Set of 5



**Connector Set
 TYPE 250
 [Reverse Lock]**
 #96187 (2-pole)
 #96188 (3-pole)
 #96189 (4-pole)
 #96190 (6-pole)

#96187

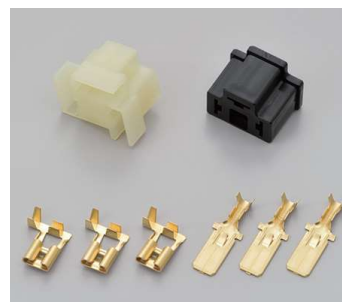

**Connector Set
 for H4 Bulb**
TYPE H4
 male connector x 1
 female connector x 1
TYPE 305
 male terminal x 3
 female terminal x 3

#96186

■ Connector Set for Turn Signal



#96191 (2-pole)
HONDA-A
LIGHT BLUE



#96192 (2-pole)
HONDA-A
ORANGE



#96300 (2-pole)
HONDA-B
LIGHT BLUE



#96301 (2-pole)
HONDA-B
ORANGE



#96302 (3-pole)
HONDA-B
WHITE



#96193 (2-pole)
SUZUKI
BLACK



#96194 (2-pole)
SUZUKI
GRAY



#96195 (2-pole)
SUZUKI
WHITE



#96199 (2-pole)
KAWASAKI
BLACK



#96200 (2-pole)
KAWASAKI
GRAY



#15414 (2-pole)
KAWASAKI
TYPE 040-HX series

■ Connector Cover Boot



#96206
Φ8xΦ22x70

#96207
Φ16xΦ37x84

#96208
Φ27xΦ42x84

OEM-colored wire

■ SQ 0.75 (14A/12V) x 2M

#93181 RED	#93182 BLACK
#93183 GREEN	#93184 LIGHT BLUE
#93185 ORANGE	#93186 BLUE
#93187 WHITE	#93188 YELLOW
#93189 GREEN/ YELLOW	#93190 BROWN
#93191 LIGHT GREEN	#93192 BLACK/ WHITE
#93193 WHITE/ BLACK	#93194 GRAY
#93195 BLACK/ YELLOW	#93196 RED/ BLACK
#93197 RED/ YELLOW	#93198 BLACK/ BROWN
#93199 ORANGE/ WHITE	
#93200 LIGHT BLUE/ WHITE	

■ SQ 1.25 (20A/12V) x 1M

#93201 RED	#93203 BLACK
#93202 GREEN	

■ SQ 2.0 (26A/12V) x 1M

#93204 RED	#93206 BLACK
#93205 GREEN	

■ SQ 0.5 (11A/12V) x 2M

#65097 RED	#65098 BLACK
#65099 GREEN	

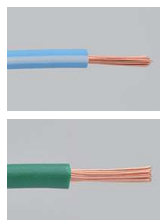

Color	Brand	Usage
RED	UNIVERSAL	
BLACK		
GREEN		
LIGHT BLUE	HONDA	Winker (Right)
ORANGE	HONDA	Winker (Left)
BLUE	HONDA	Headlight (High Beam)
WHITE	HONDA	Headlight (Low Beam)
YELLOW	YAMAHA	Headlight (High Beam), Taillight
GREEN/YELLOW	HONDA	Taillight
BROWN	YAMAHA	ACC Wire
LIGHT GREEN	SUZUKI	Winker (Right)
BLACK/WHITE	SUZUKI	GND Wire
WHITE/BLACK	SUZUKI	Taillight
GRAY	KAWASAKI	Winker (Right)
BLACK/YELLOW	KAWASAKI	GND Wire
RED/BLACK	HONDA	ACC Wire
RED/BLACK	KAWASAKI	Headlight (High Beam)
RED/YELLOW	KAWASAKI	Headlight (Low Beam)
BLACK/BROWN	HONDA	ACC Wire
ORANGE/WHITE	HONDA	Position Light
LIGHTBLUE/WHITE	HONDA	Position Light

Fuel Hose (1M)

■2-layered Fuel Hose



- #96460 $\Phi 4 \times \Phi 8$, 1M
- #96461 $\Phi 5 \times \Phi 10$, 1M
- #96462 $\Phi 6 \times \Phi 10$, 1M
- #96463 $\Phi 8 \times \Phi 13$, 1M
- #96464 $\Phi 10 \times \Phi 15$, 1M
- 2-layered
- Pressure capacity 1.0MPa
- Heatproof temperature 100°C
- Incl. 5pcs of clip

- ✘ Not for brake fluid
- ✘ Not for FI models

■Hose Clamp



- | | |
|------------------|-------------------|
| #91238 $\Phi 6$ | #91244 $\Phi 12$ |
| #91239 $\Phi 7$ | #91245 $\Phi 13$ |
| #91240 $\Phi 8$ | #91246 $\Phi 14$ |
| #91241 $\Phi 9$ | |
| #91242 $\Phi 10$ | ● 2pcs / set |
| #91243 $\Phi 11$ | ● Material: Steel |

■Hose Clip



- | | |
|------------------|-------------------|
| #91420 $\Phi 6$ | ● 10pcs / set |
| #91422 $\Phi 8$ | ● Material: Steel |
| #91423 $\Phi 9$ | |
| #91424 $\Phi 11$ | |
| #91425 $\Phi 13$ | |

■Fuel Hose Stopper



- #91110
- For hose outer diameter up to 15mm
- ✘ Not for negative pressure cock
- ✘ Not for FI models

Front Lever Lock



- #97636 (ORANGE)
- #97637 (BLACK)
- #97638 (GREEN)
- #97639 (RED)

Grip mount type
I.D. 36mm

Seat Repair Sticker



- 84705 (M-BLACK)
- 84708 (BLACK)
- 84706 (M-BROWN)
- 84709 (BROWN)
- 84707 (M-BEIGE)
- 84710 (BEIGE)

110x170mm
 ※ M- ▶matte

Protection Sticker

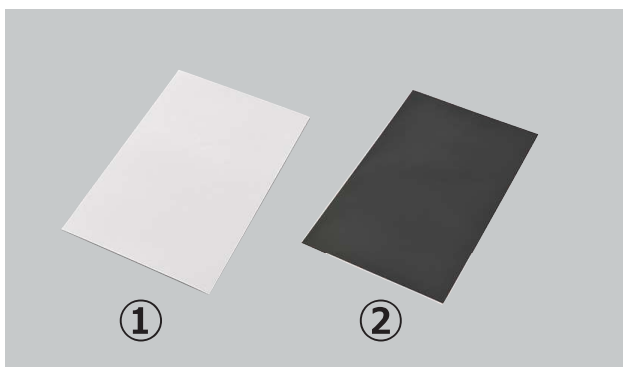

- ① #69803 (CLEAR)
- ② #69816 (BLACK)

130x200mm

Anti-slip Sticker

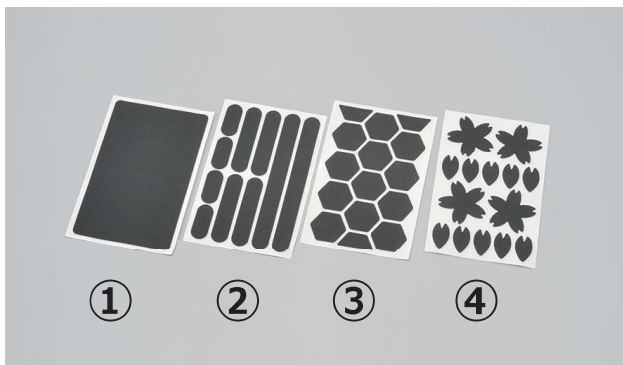

- ① #17381 (PLAIN)
- ② #17391 (SLOT)
- ③ #17389 (HONEYCOMB)
- ④ #17379 (SAKURA)

License Number Plate Holder (Germany)



#89854

- Aluminum
- Anodized black
- For German number plate 180x200



website



Instagram



Youtube



DAYTONA

<https://daytona-europe.com>

